



ENVIRONMENT SOLUTIONS

Preventing hydrometeorological disasters

Presenting The “NoFloods Barrier”
The Original Solution since 1998

EASY AND LOGIC
REVOLUTIONIZING

THE WAY TO STORE UNLIMITED AMOUNTS OF LIQUIDS



Environment Solutions – Profile Video



NoFloods
By Environment Solutions

We reduce devastations from Flooding

The Mobile Flood Barrier is the replacement of sandbags, and probably the most efficient solution for large scale flood protection and temporary wastewater storage.

- Fast deployment
- Manpower efficient
- Deployment in 200 meter sections
- Preventive and curative deployment



⇒ In 5 hours, 5 men using a vehicle can deploy 1000 meters of flood barrier (80 cm flood water)

The Concept of NoFloods Mobile Barrier

“We Fight Water with Water”

“probably the most efficient solution for temporary and large scale flood protection” (+200 meters)

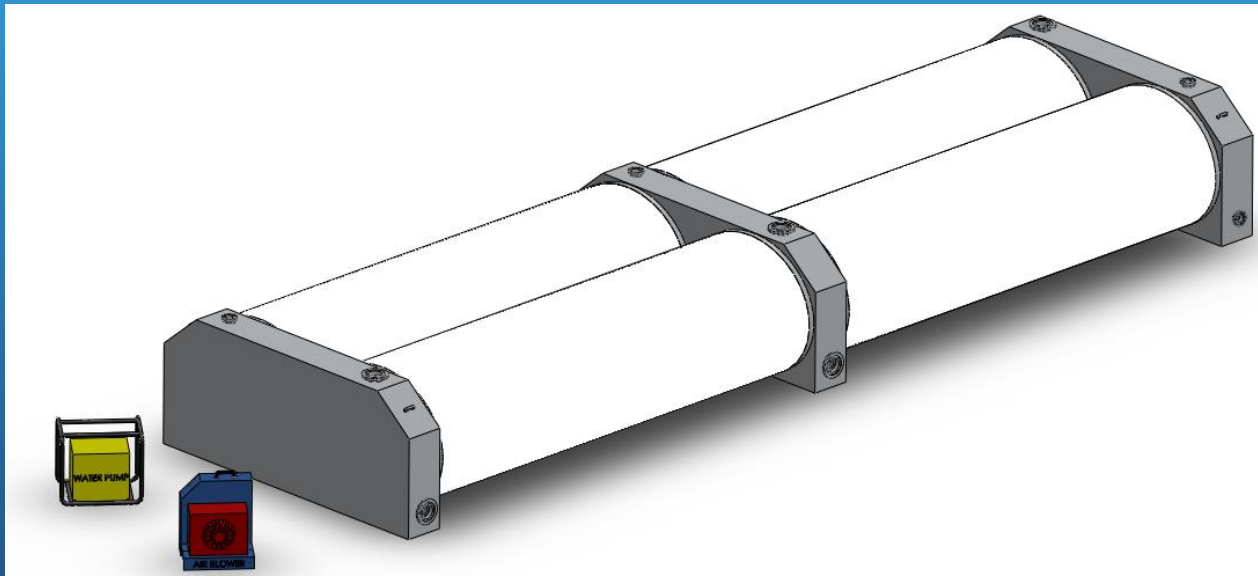

The Mobile Dam replaces the use of sandbags in case of flooding. In just five hours, 5 men using a tractor are able to lay out 5 km of mobile dam. By comparison, it would require around 7,000 men to do the same job in five hours using sandbags.

Ét koncept

Mange anvendelsesmuligheder

Dyke Protection



Oil Spill Protection



Flood Protection



Containment Reservoirs

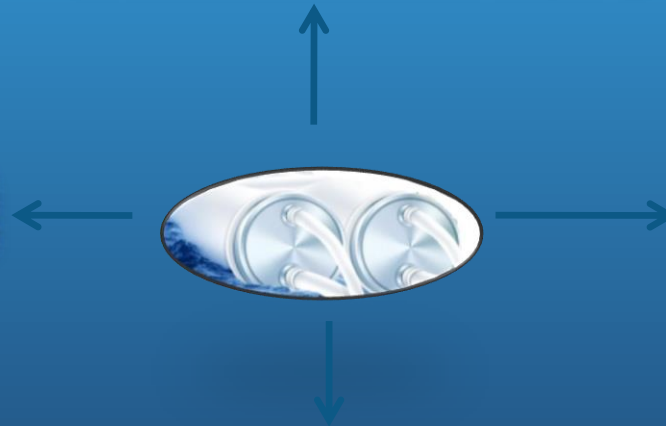

LIVE CASE UNGARN



6 LIVE CASES FRANKRIG



CASE



Jyllinge, Danmark 2015

Storm varsling – EGON...

- Jyllinge / Roskilde truet.... Igen...
- 83.000 indbyggere I risikozonen
- Beboere stadig ikke kommet sig over BODIL, der ramte i 2014
- Ingen løsninger har været etableret siden BODIL.
- EGON forventes at ankomme inden for 24-48 timer...



Krisestyringscenter etableret

- 16 timer til EGON lander...
- Detaljeret aktionsplanlægning
- Mobilisering af ressourcer
- Beslutning vedr. forv. vandhøjde samt beskyttelse
- Prioritering
- ES bedt om at komme med ALT hvad de havde af udstyr.

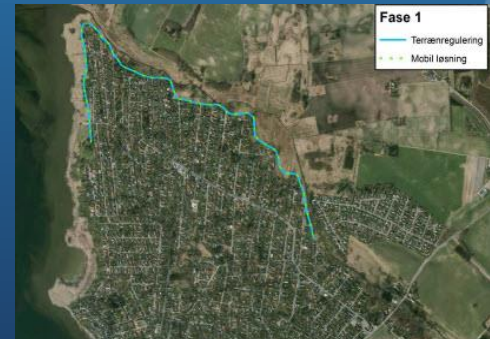
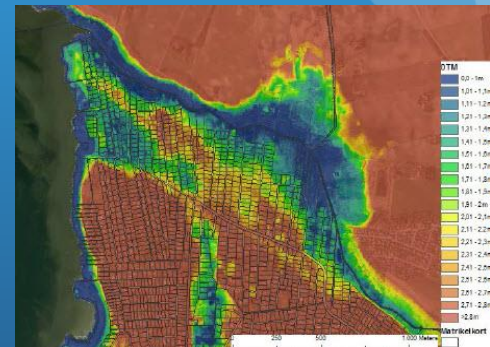

Mobilisering af ressourcer

- BEHOV: Ca. 1,6 km beskyttelse
- Fysisk inspektion på stedet
- ES medbringer al tilgængeligt udstyr til Jyllinge-Nordmark.
- Beredskabsstyrelsen ansvarlig for pumping.
- ES og Roskilde Beredskab ansvarlig for udlægning af dæmninger.

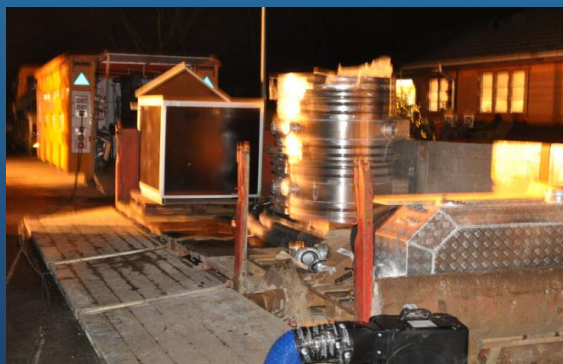
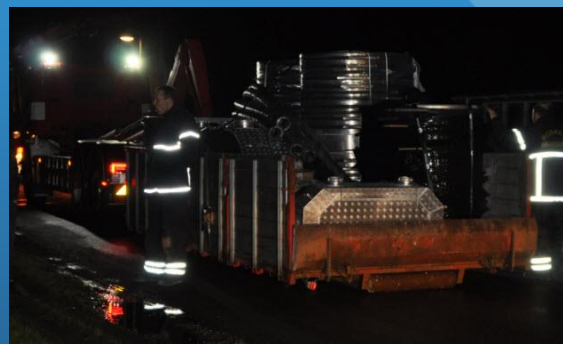

Kort over udlægning

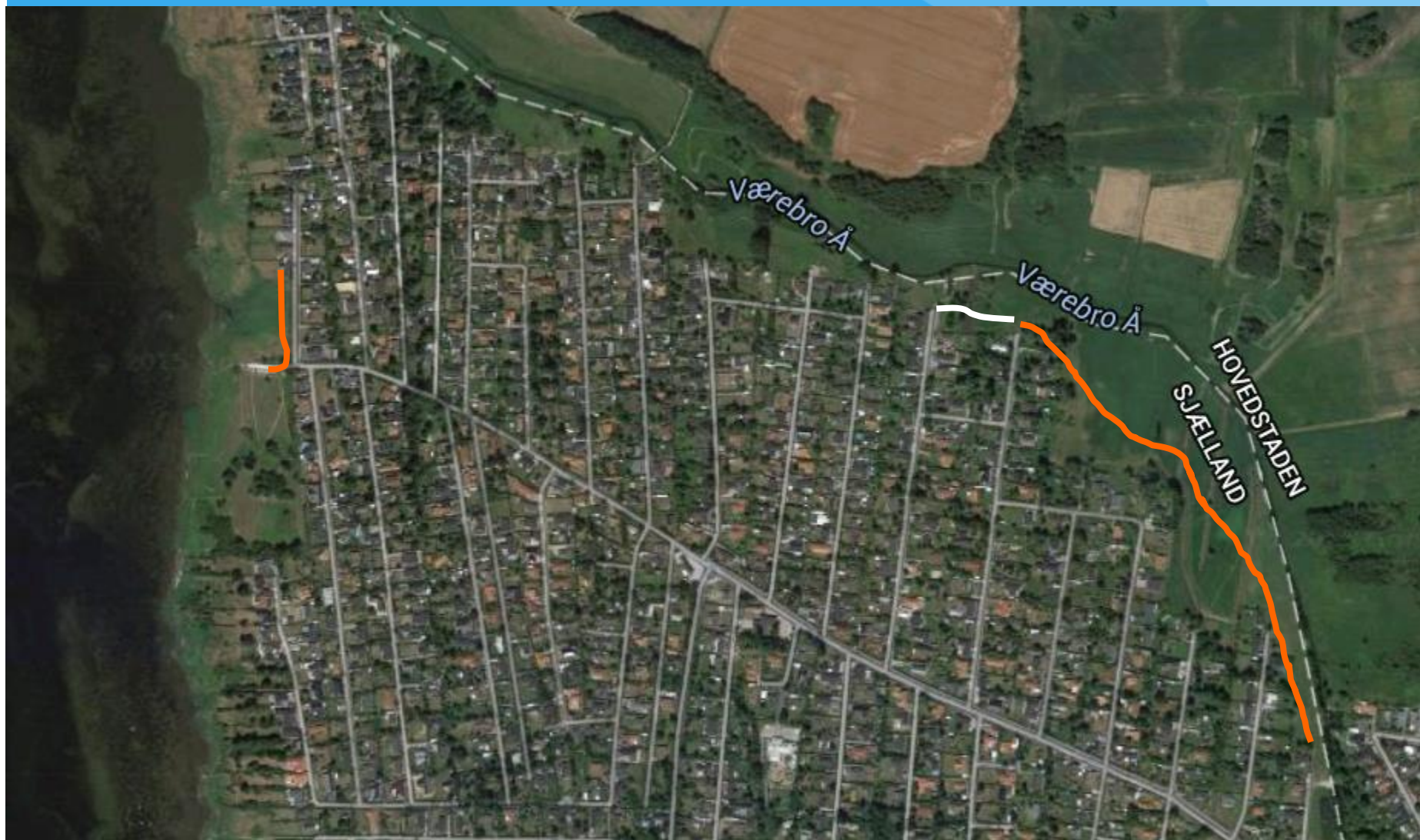

Udlægning af hhv. 850 m + 125 m



850 m NoFloods Barrier = 2.040.000 liter vand (l/kg)

Udlægningsmetoder

1. Kørende udlægning



2. Manuel udlægning

3. Rullende udlægning



Fighting floods



Konstant overvågning



Succesfuld beskyttelse!



Jyllinge – FØR og UNDER



Jyllinge – Oprydning...



Jyllinge – Oprydning...



Debriefing...

OVERORDNET: VI HAVDE EN MEGET FIN OPLEVELSE

- Kommunikationen ml. Roskilde Beredskab og ES fungerede fint...!
- Roskilde Beredskab / Kommune var godt forberedt denne gang... Eller hvad?!
 - Sikring af åer, kloakeringer, drænrør, mv.
- Træning af det lokale beredskab er essentielt for succes...
 - KUN 1-2 udvalgte "kaptajner" som ansvarlige
 - Specialister i pumper
 - Specialister i udlægning

Debriefing...

- Deklarering af området som værende et "Emergency Area"
 - Ingen adgang for uvedkommende
 - Struktureret område for materiel
- Borgernes involvering er dejligt... Og nødvendigt... men må struktureres
- Fremkommelighed
 - Der skal etableres fremkommelighed for materiel.
 - Beredskabsvej.

Environment Solutions - Export

- ES er primært en eksportvirksomhed (90% stigende).
- ES er i start-fasen på eksportmarkedet.
- Danmark udgør kun en meget lille del af omsætning.
- ES befinder sig i B2G markedet
- Salg primært gennem offentlige udbud.



TAK !

David Conrad Konge

Environment Solutions

Email: dk@environmentsolutions.dk

Mobile: +45 6146 6396