

Energy data

What for?

PhD student

Riccardo Bergamini

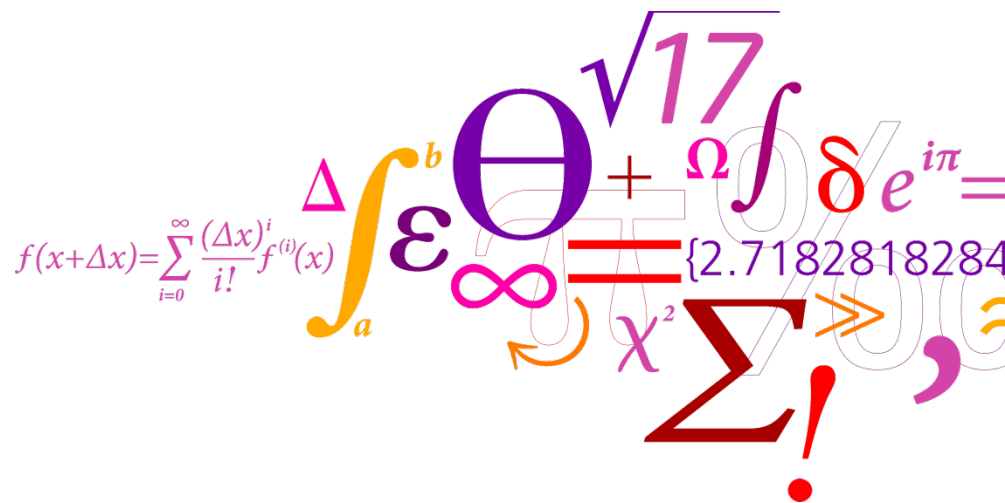

Introduction



Industry

Introduction

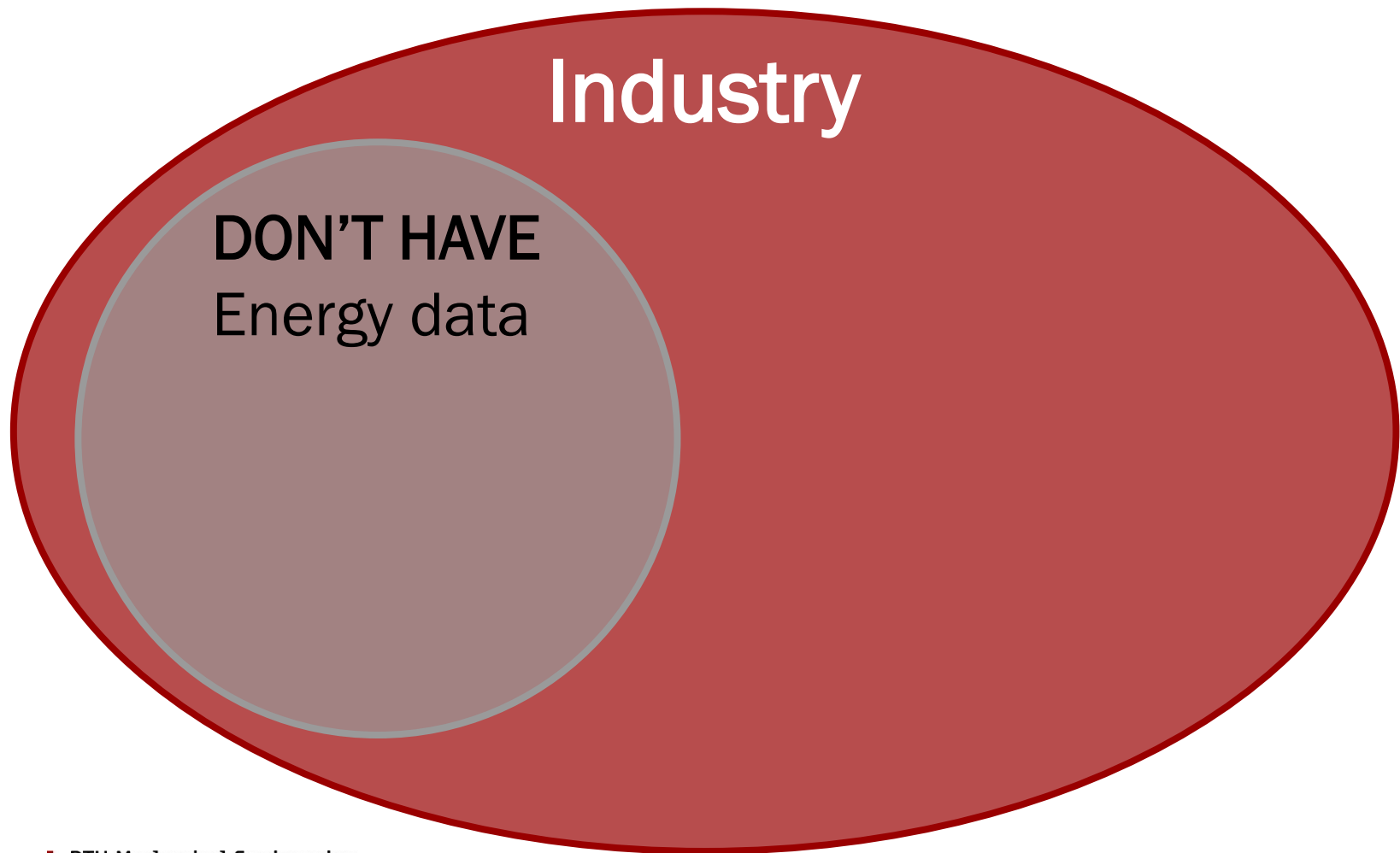

Introduction

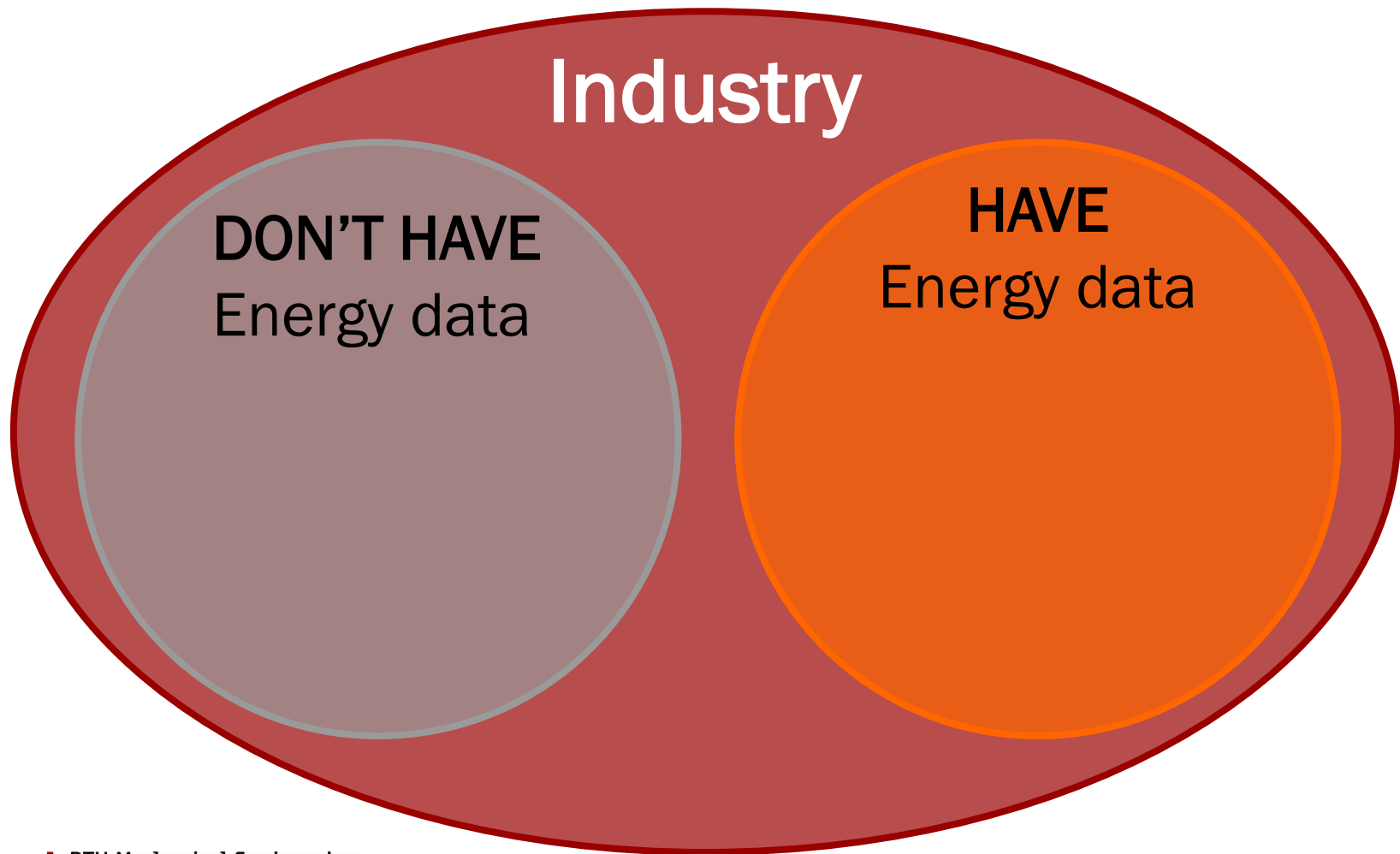

Introduction

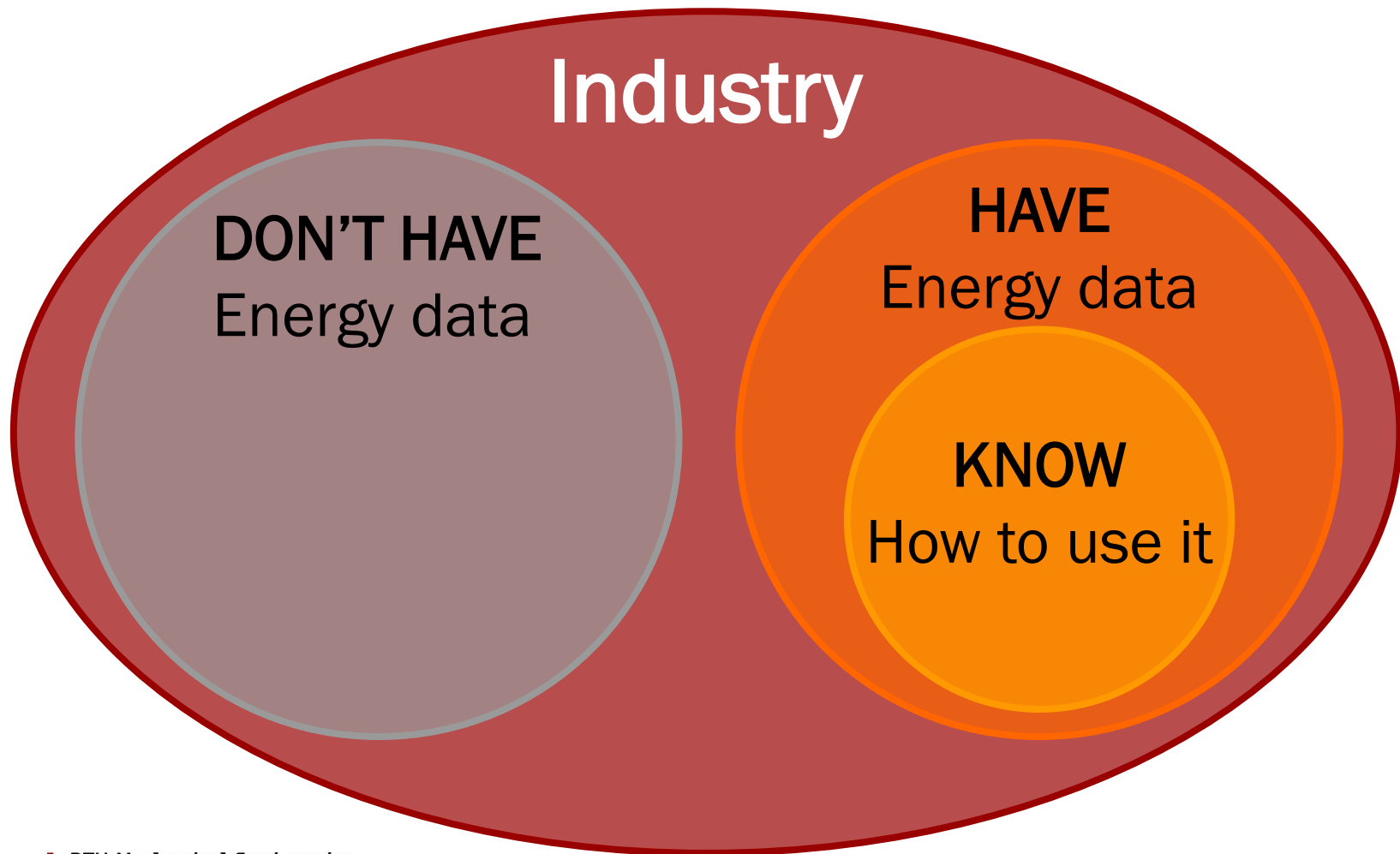

Main questions

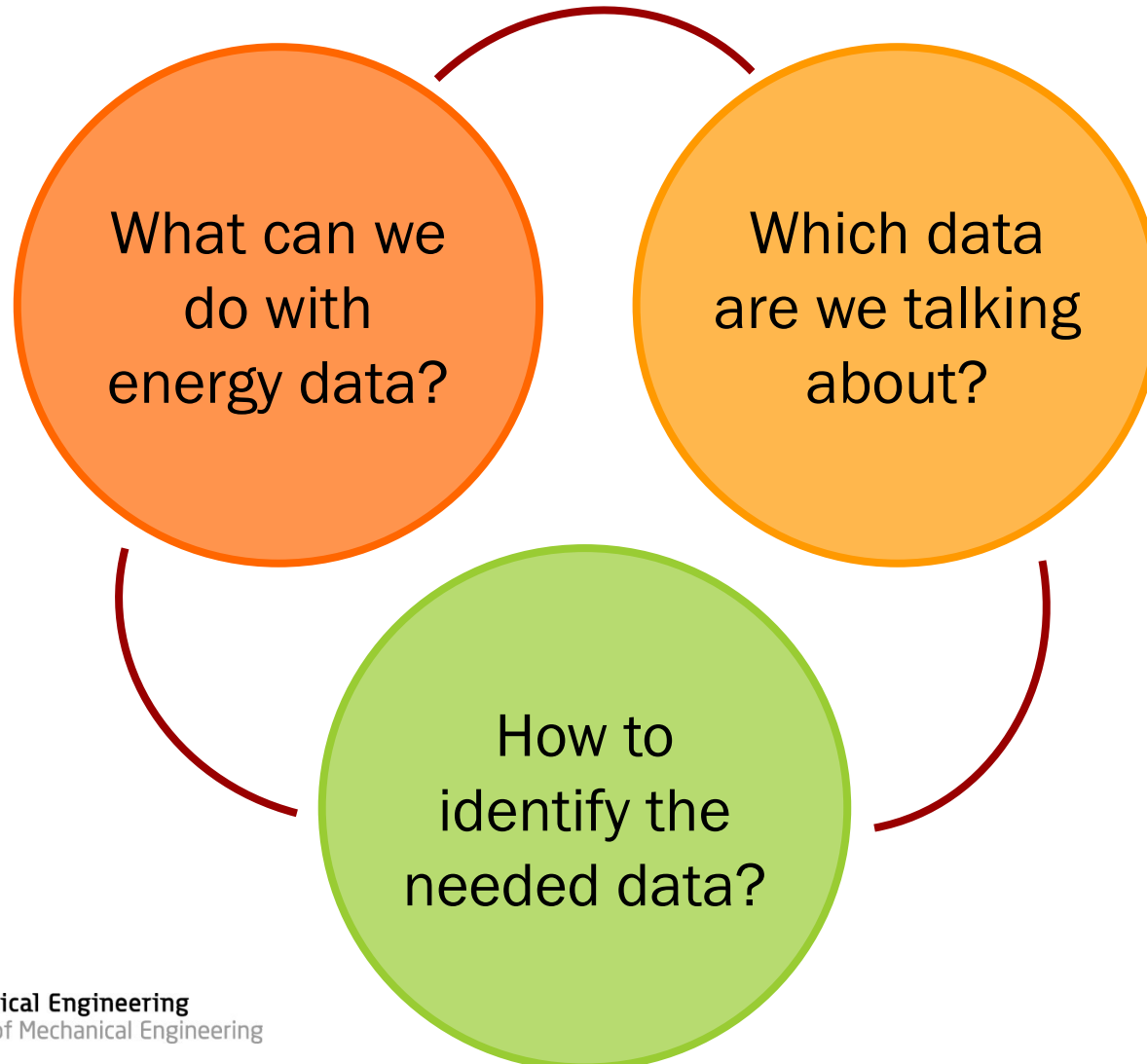

1.1 What to use data for?

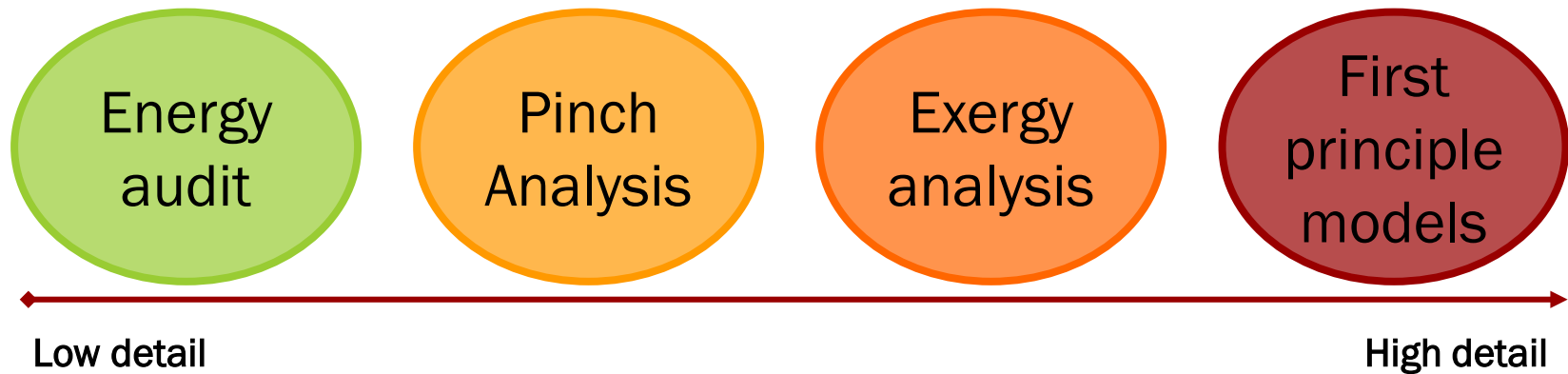

1.2 PINCH ANALYSIS

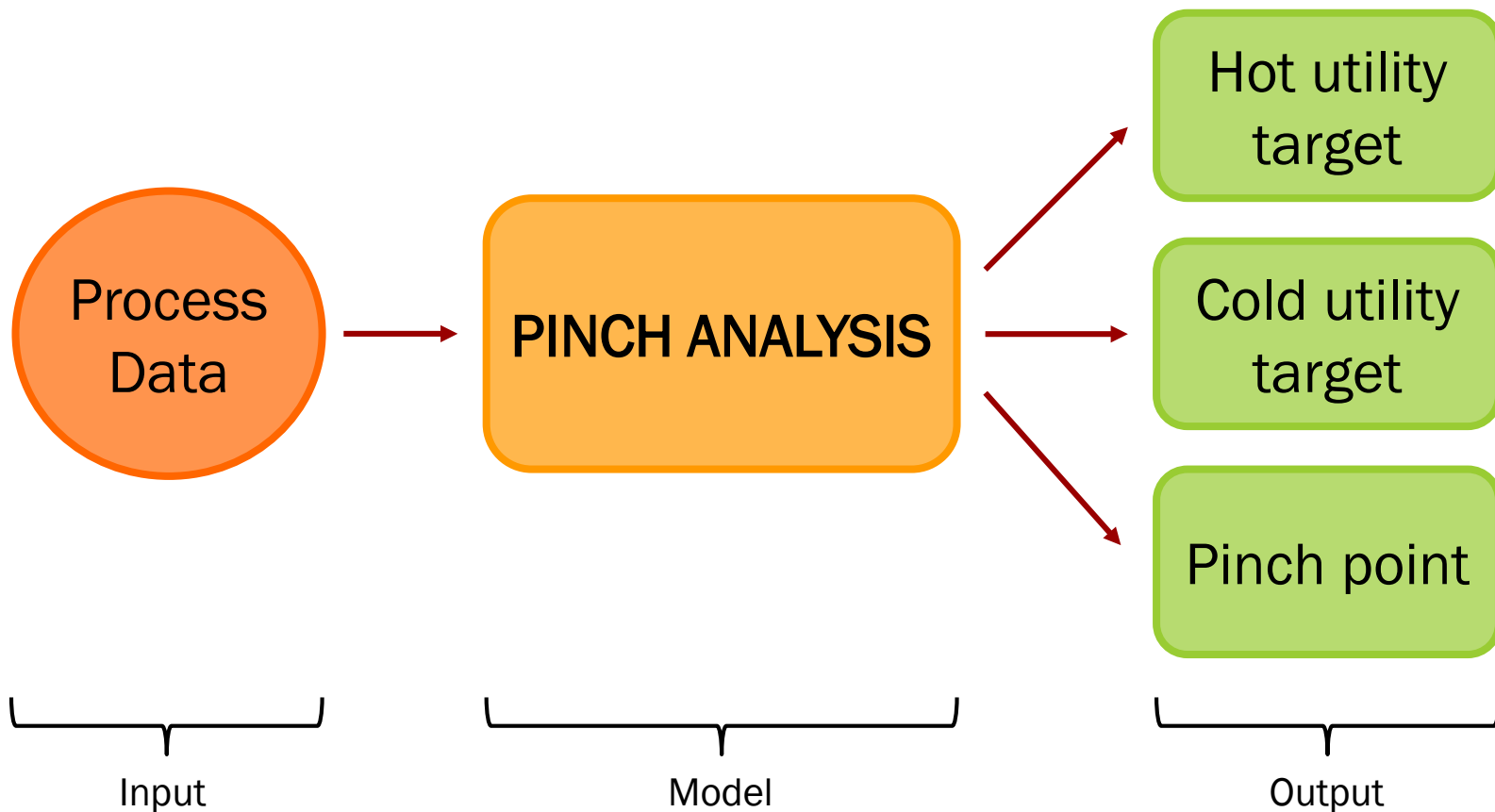

1.3 PINCH ANALYSIS – Grand Composite Curve

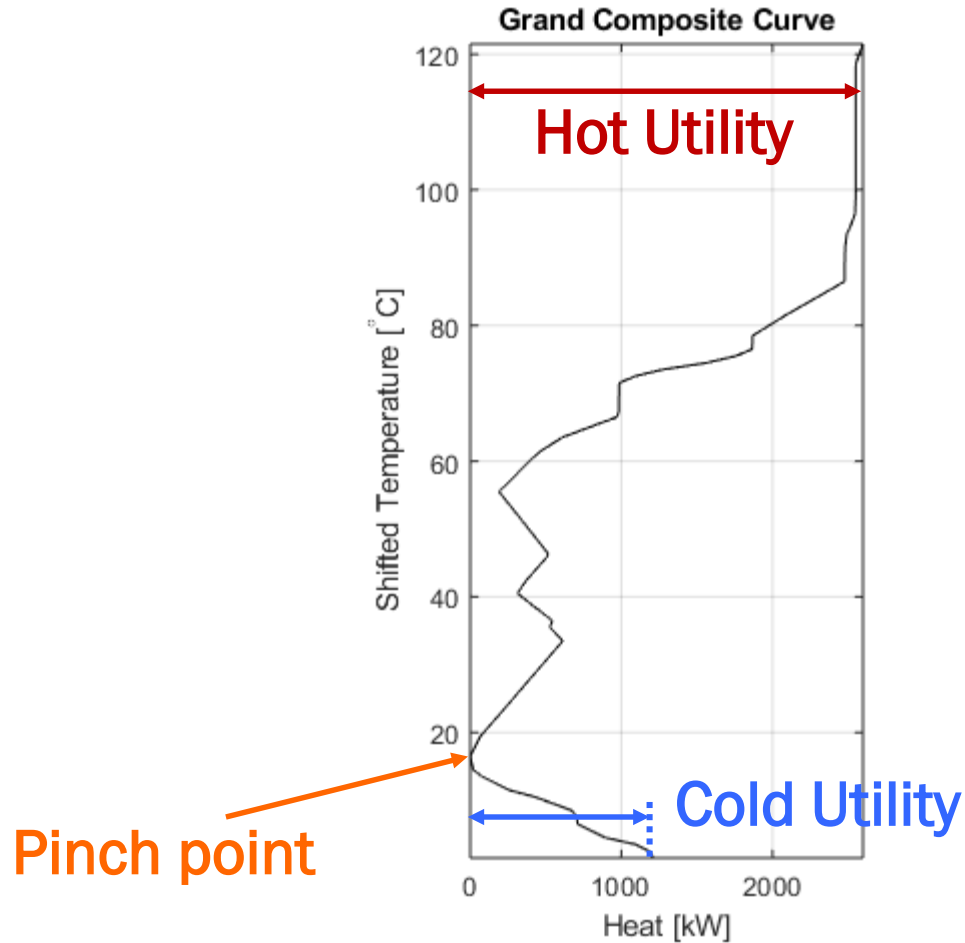

1.4 Case study

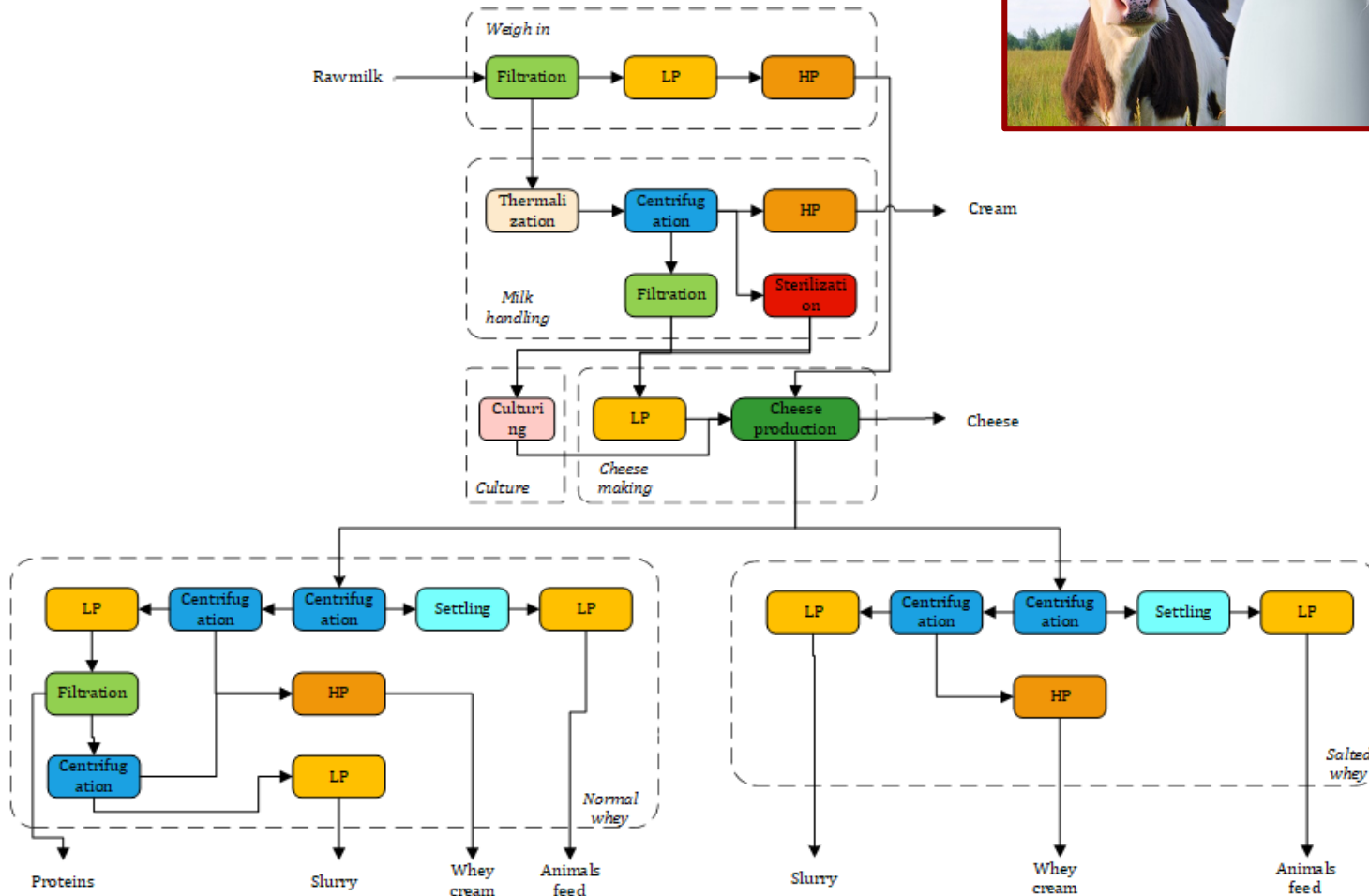

1.5 Application of Pinch analysis – Energy targeting

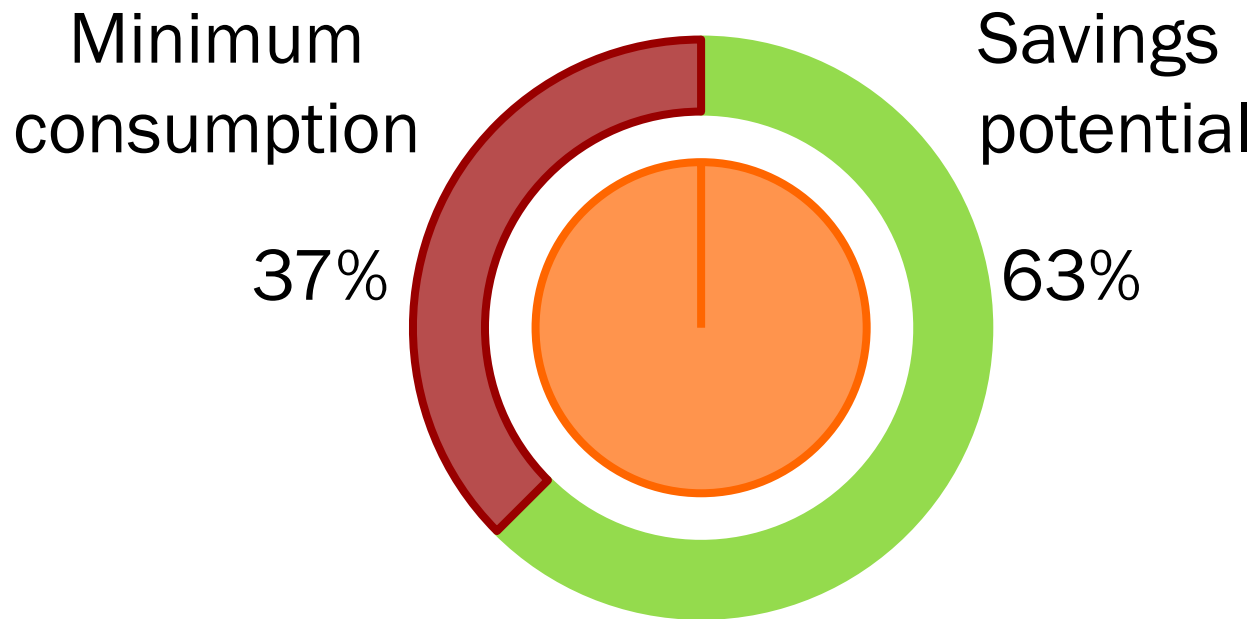

1.6 Application of Pinch Analysis – Retrofit results

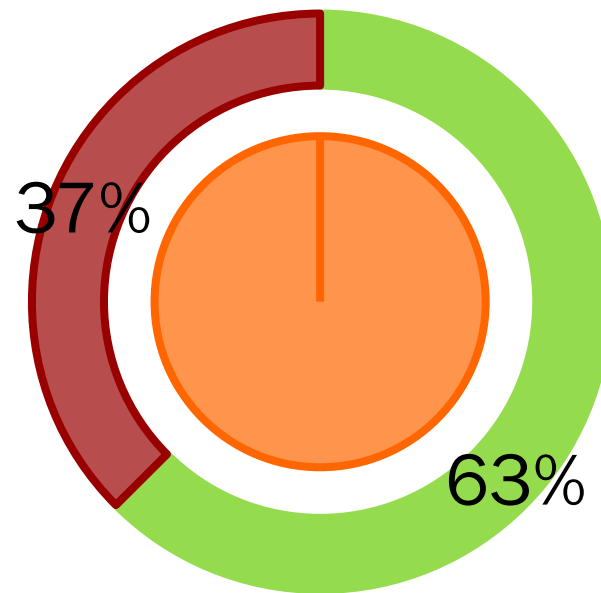

1.6 Application of Pinch Analysis – Retrofit results

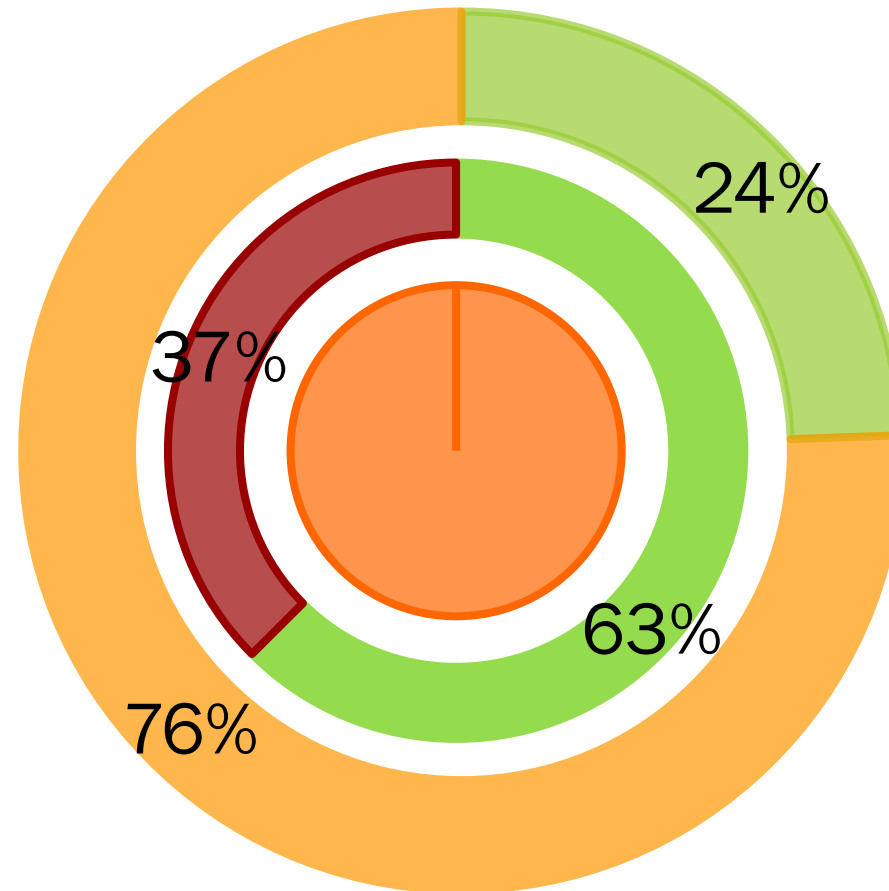

1.6 Application of Pinch Analysis – Retrofit results

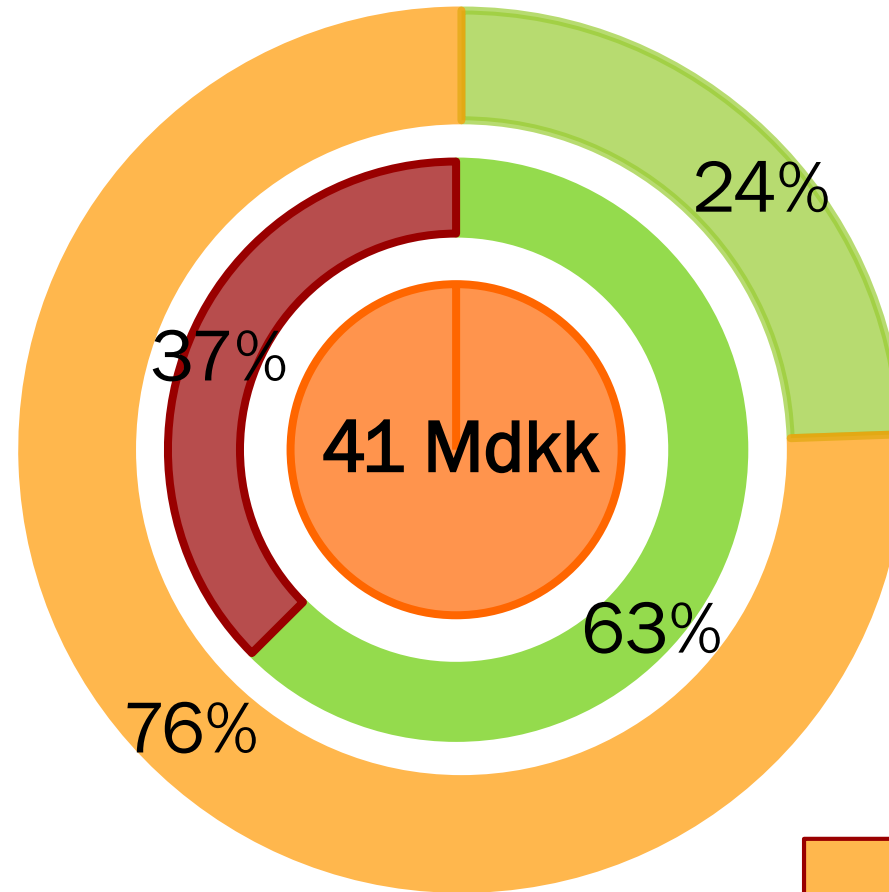

PBT = 4.1 years

2.1 Which data are we talking about?



REQUIRED
DATA

2.1 Which data are we talking about?

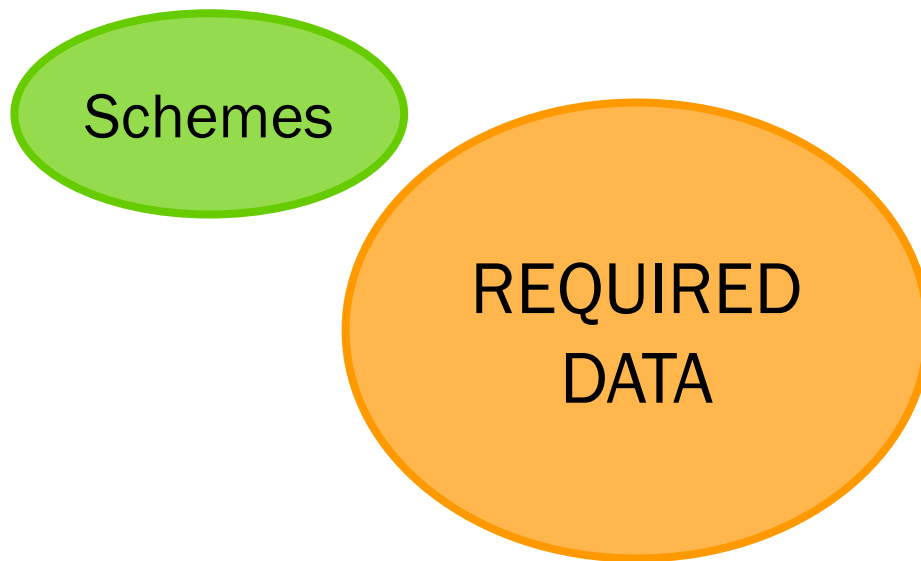

2.1 Which data are we talking about?

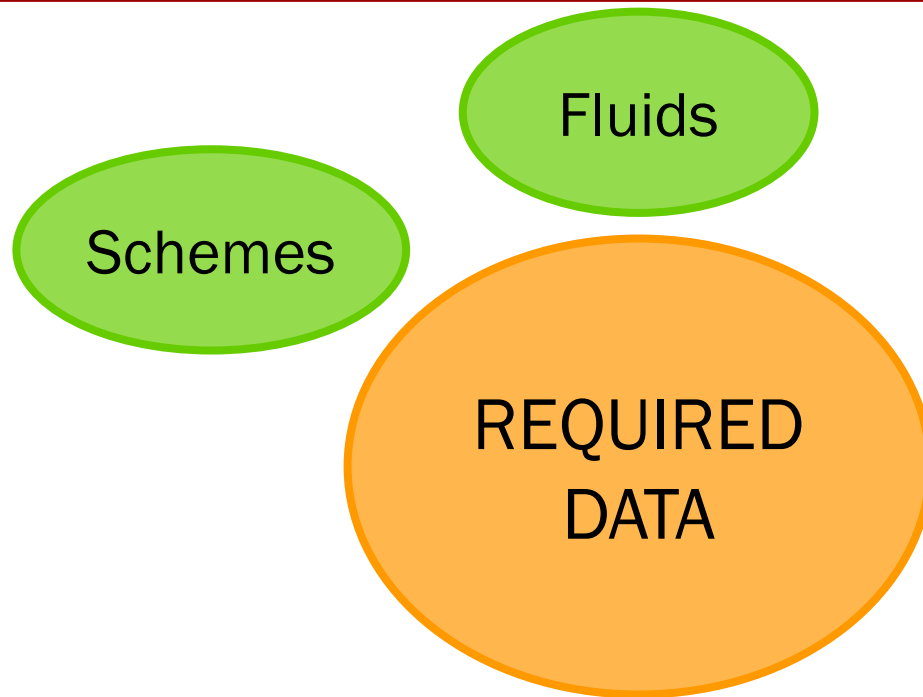

2.1 Which data are we talking about?

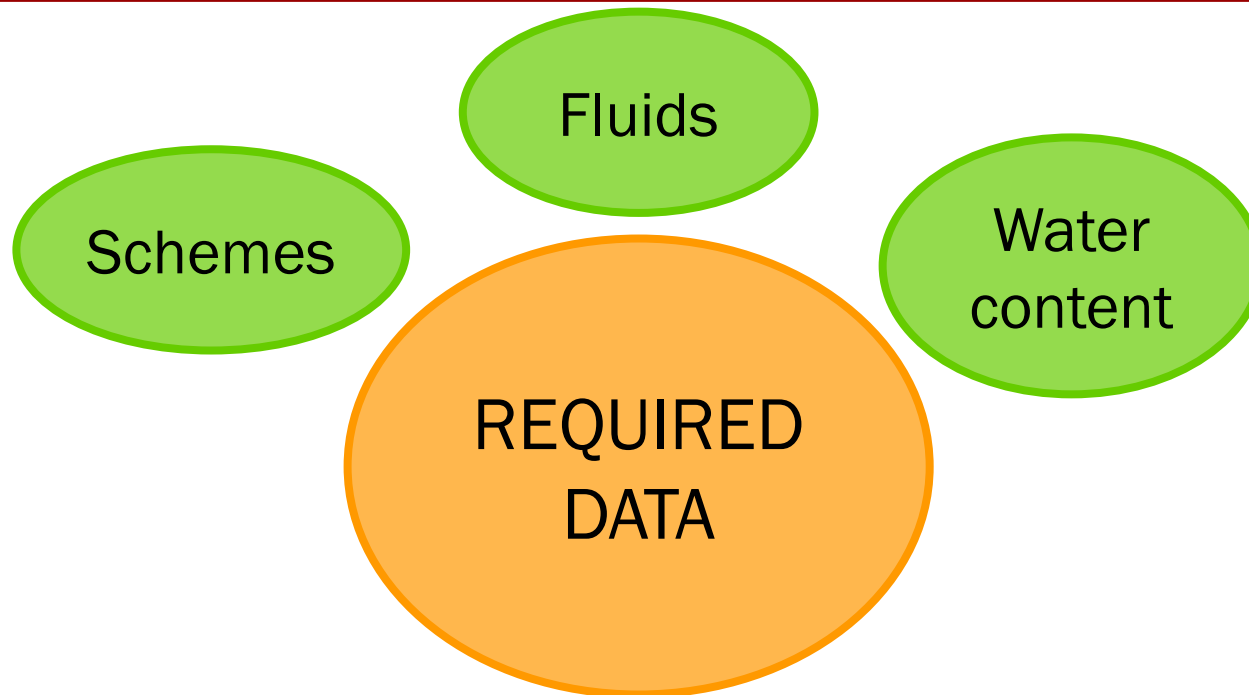

2.1 Which data are we talking about?

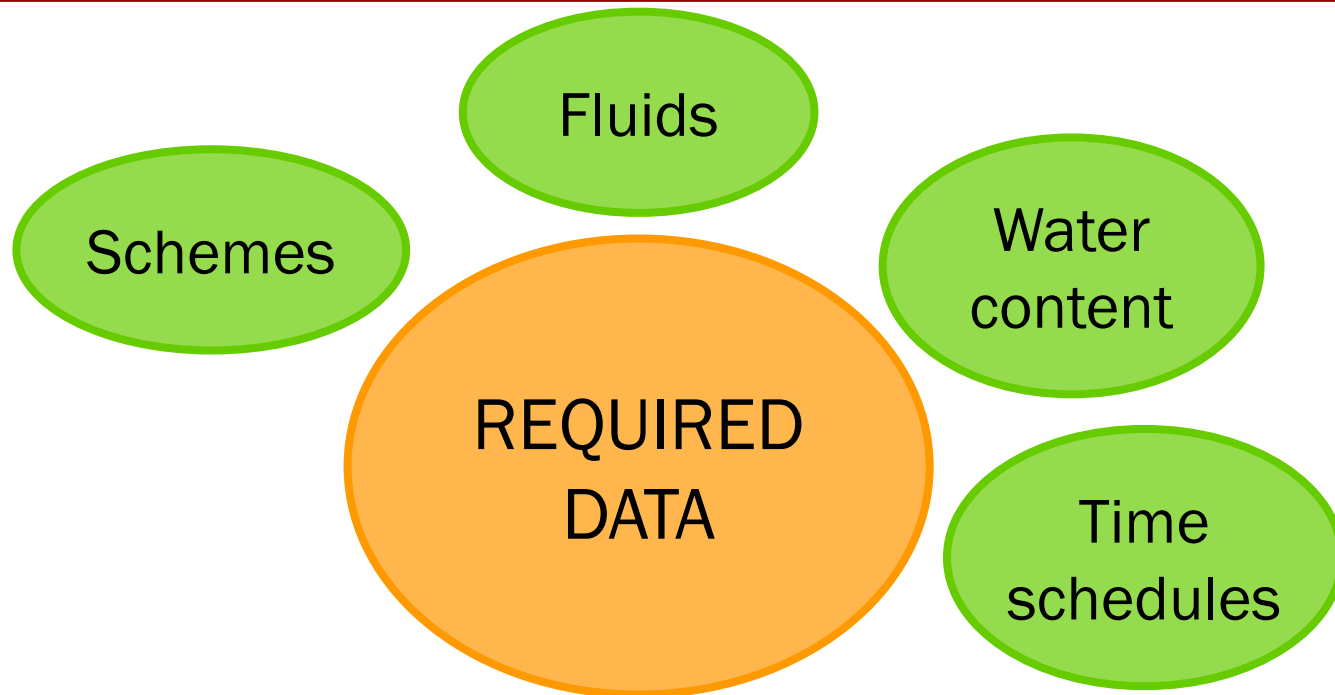

2.1 Which data are we talking about?

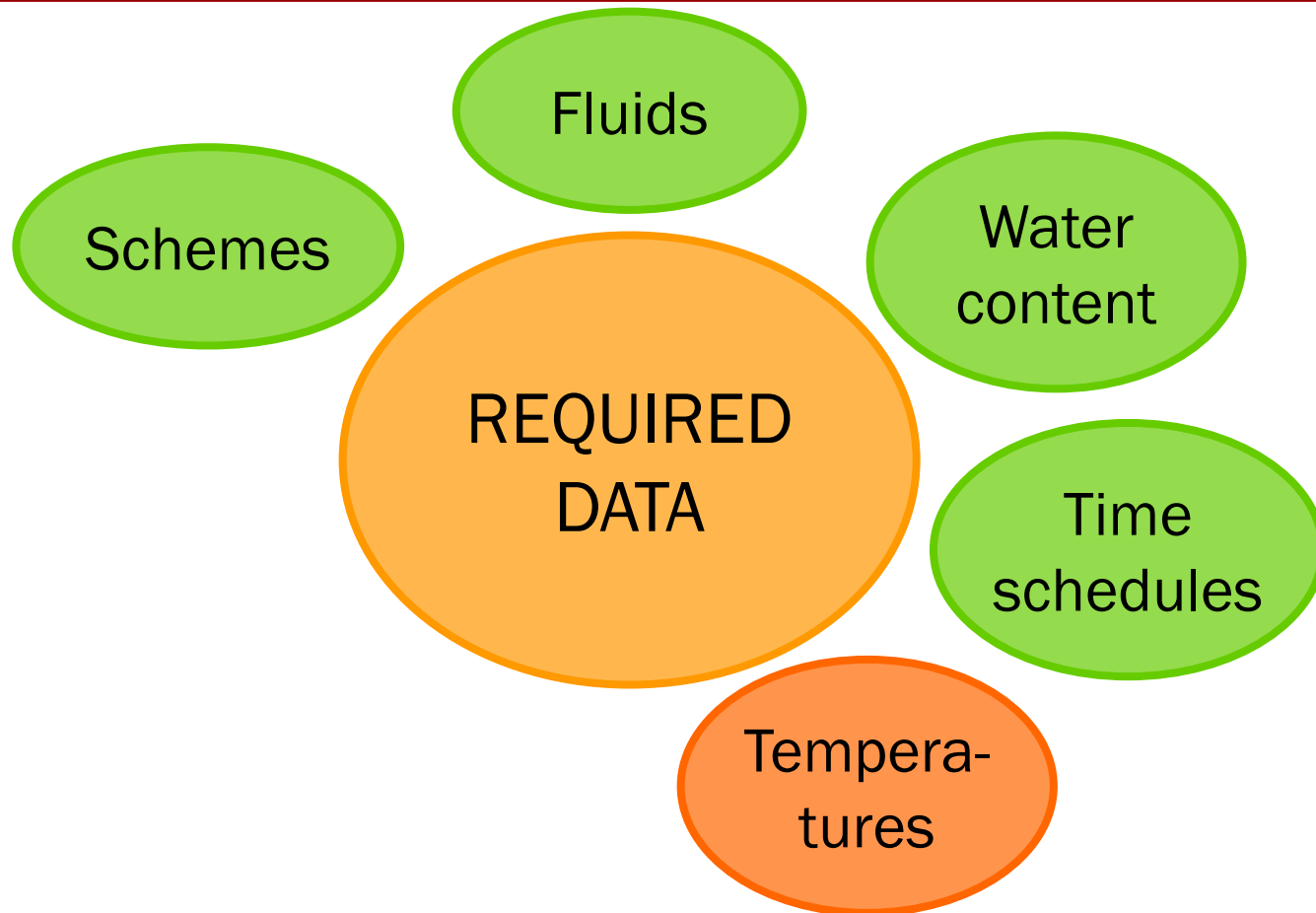

2.1 Which data are we talking about?

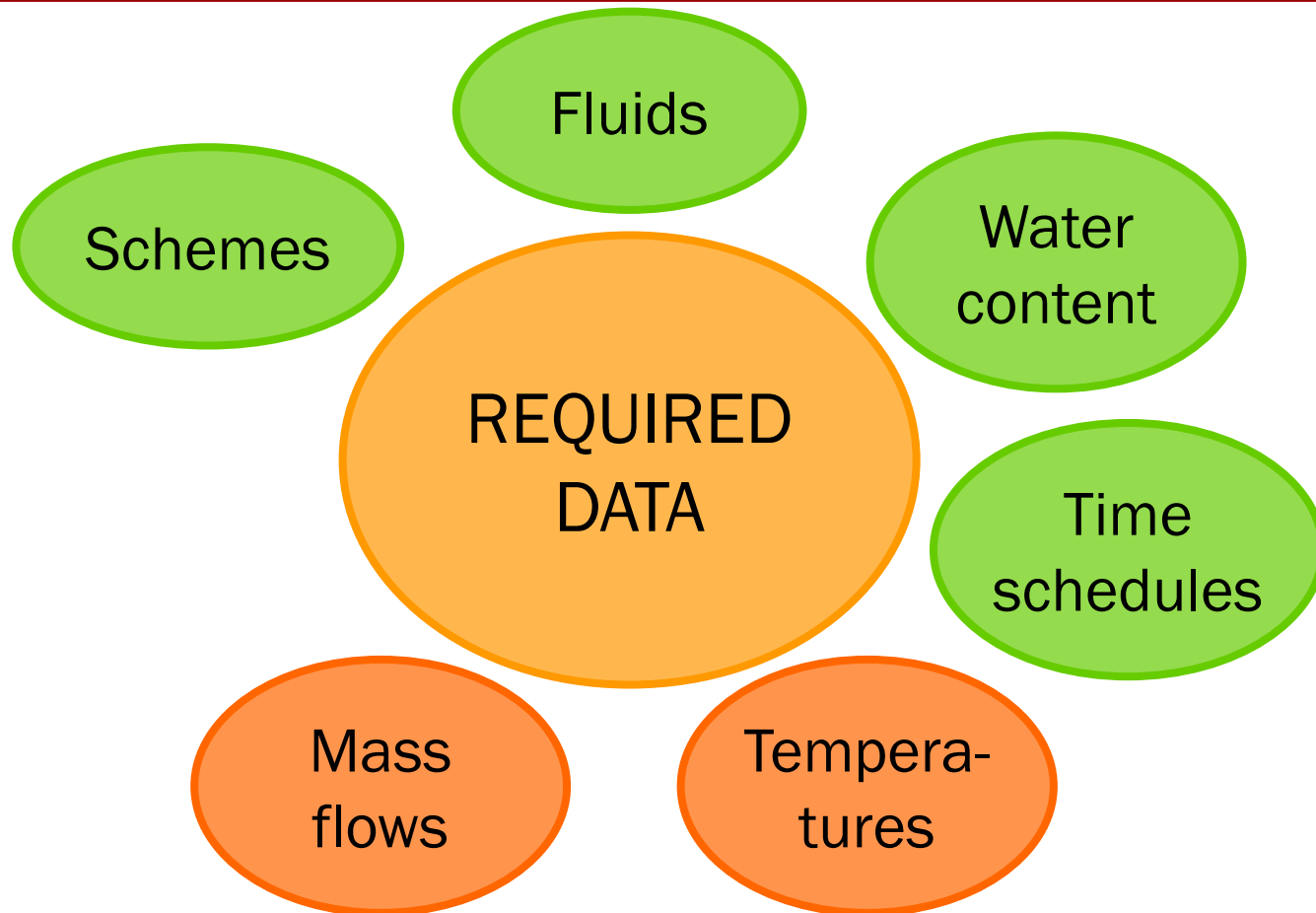

2.1 Which data are we talking about?

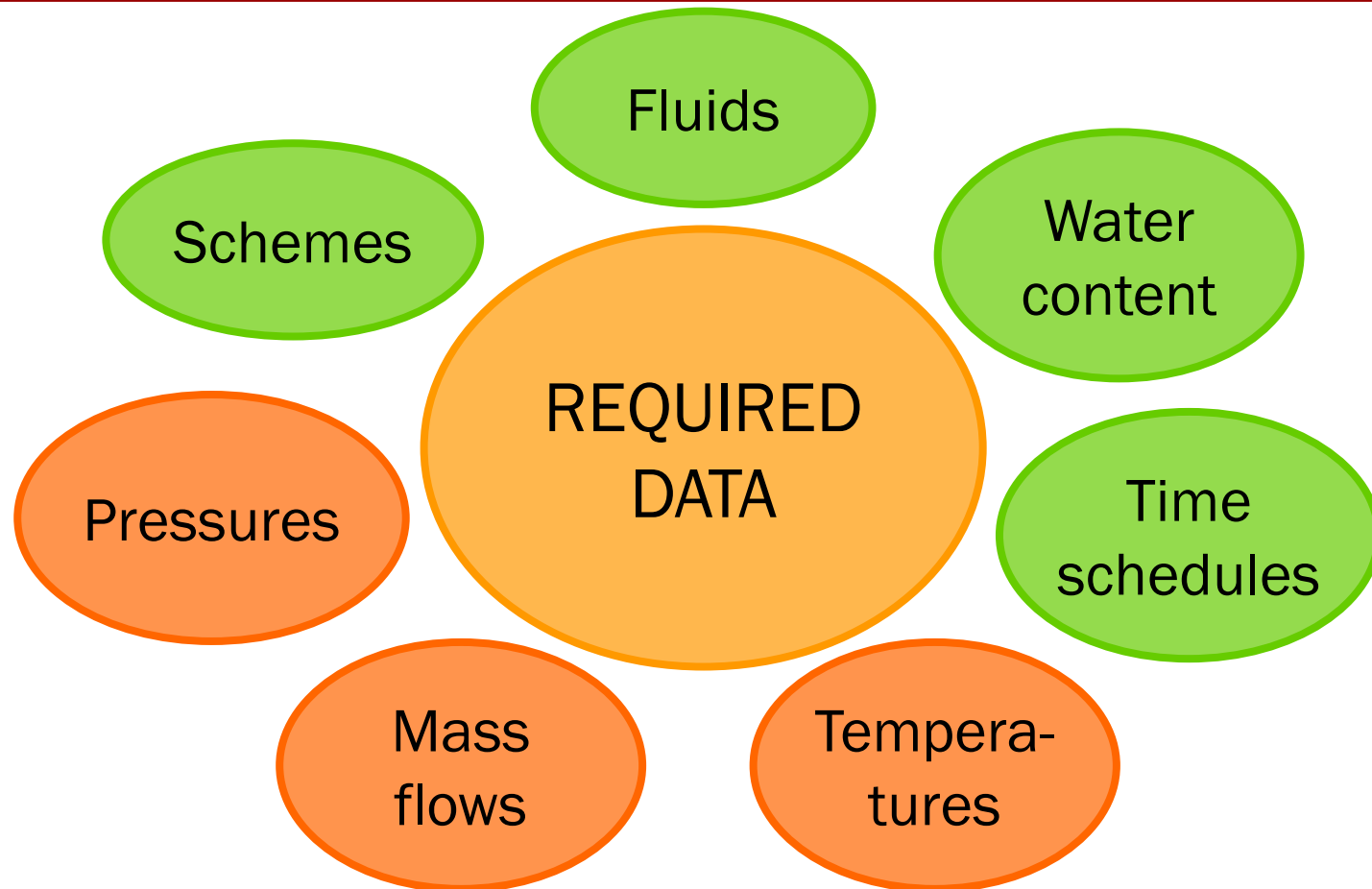

2.2 Data acquisition – measurements involved

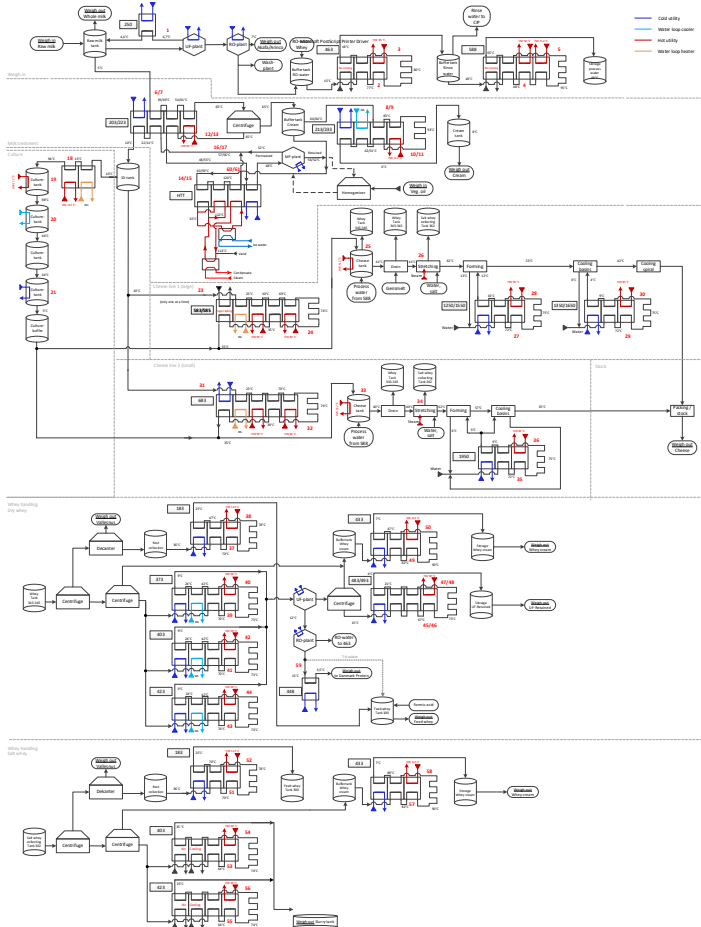

Data complexity:

- 33 mass flow rates
- 104 temperatures
- 62 total solids contents

2.2 Data acquisition – measurements involved

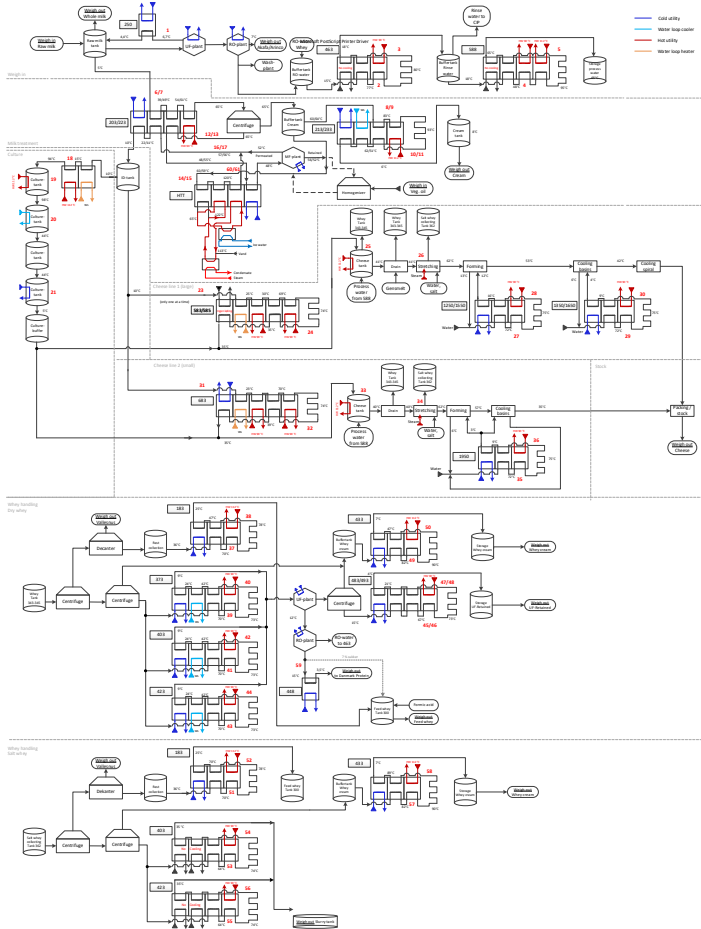

Data complexity:

- 33 mass flow rates
- 104 temperatures
- 62 total solids contents



205
measurements

2.2 Data acquisition simplification strategy

Step 1: Rough data acquisition

Step 2: Uncertainty analysis

Step 3: Sensitivity analysis

Step 4: Allowed uncertainty maximization

Step 5: Detailed data acquisition

2.2 Data acquisition simplification strategy

Step 1: Rough data acquisition



No ad-hoc
measurements

Step 2: Uncertainty analysis

Step 3: Sensitivity analysis

Step 4: Allowed uncertainty maximization

Step 5: Detailed data acquisition

2.2 Data acquisition simplification strategy

Step 1: Rough data acquisition

No ad-hoc
measurements

Step 2: Uncertainty analysis

Acceptable
uncertainty

Step 3: Sensitivity analysis

Step 4: Allowed uncertainty maximization

Step 5: Detailed data acquisition

2.2 Data acquisition simplification strategy

Step 1: Rough data acquisition

No ad-hoc
measurements

Step 2: Uncertainty analysis

Acceptable
uncertainty

Step 3: Sensitivity analysis

Important
parameters

Step 4: Allowed uncertainty maximization

Step 5: Detailed data acquisition

2.2 Data acquisition simplification strategy

Step 1: Rough data acquisition

No ad-hoc
measurements

Step 2: Uncertainty analysis

Acceptable
uncertainty

Step 3: Sensitivity analysis

Important
parameters

Step 4: Allowed uncertainty maximization

Required
precision

Step 5: Detailed data acquisition

2.3 Data acquisition simplification strategy

Step 1: Rough data acquisition



No ad-hoc
measurements

205 process values taken from:

- Existing measurement system
- Expert review
- Annual production and consumption records

2.4 Data acquisition simplification strategy

Step 2: Uncertainty analysis



High uncertainty
assigned to the
rough data

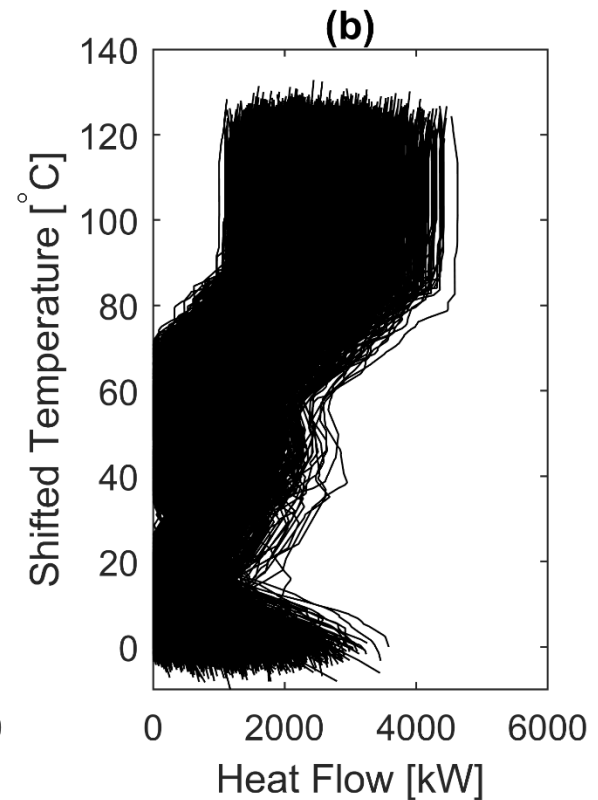
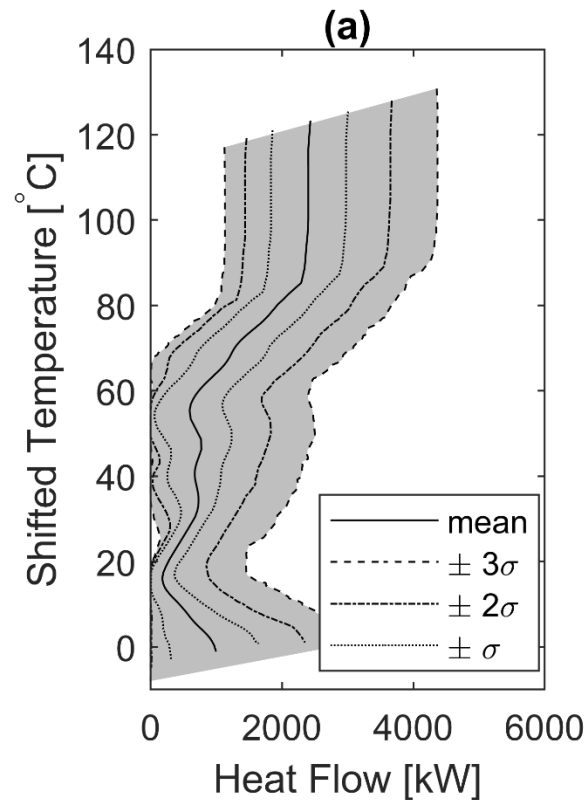

2.5 Data acquisition simplification strategy

Step 3: Sensitivity analysis



Important
parameters

Of the 205 required values...

...**only 44 need precision** in their definition!

2.6 Data acquisition simplification strategy

Step 4: Allowed uncertainty maximization

Required precision

44 parameters

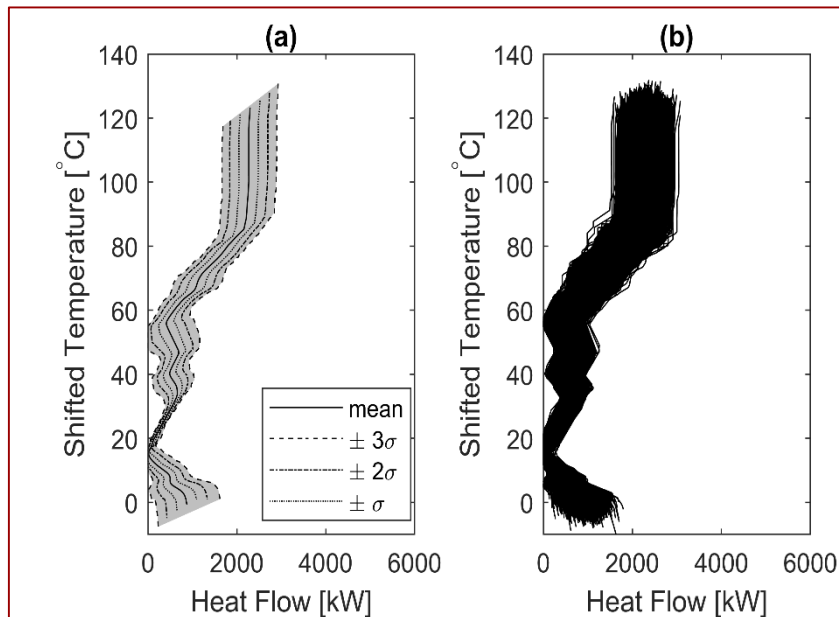

205 parameters

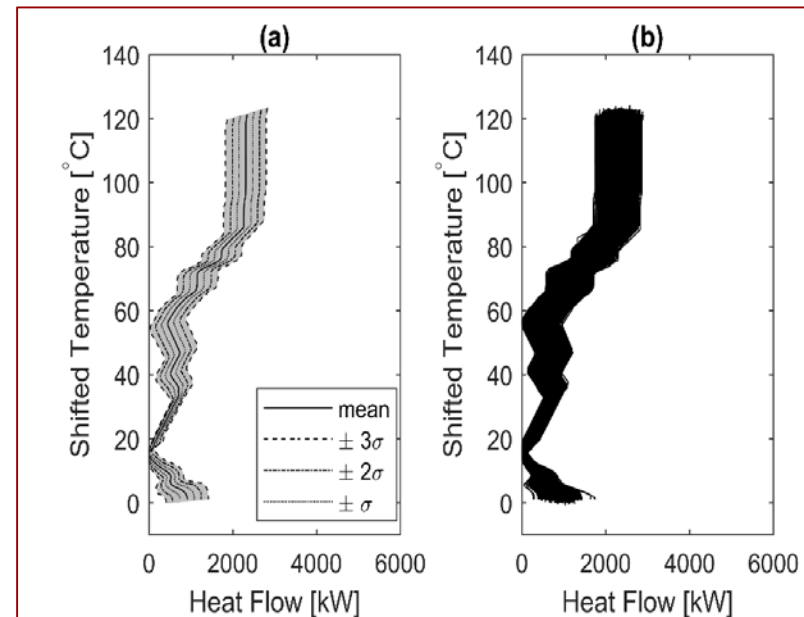

2.7 Data acquisition simplification strategy

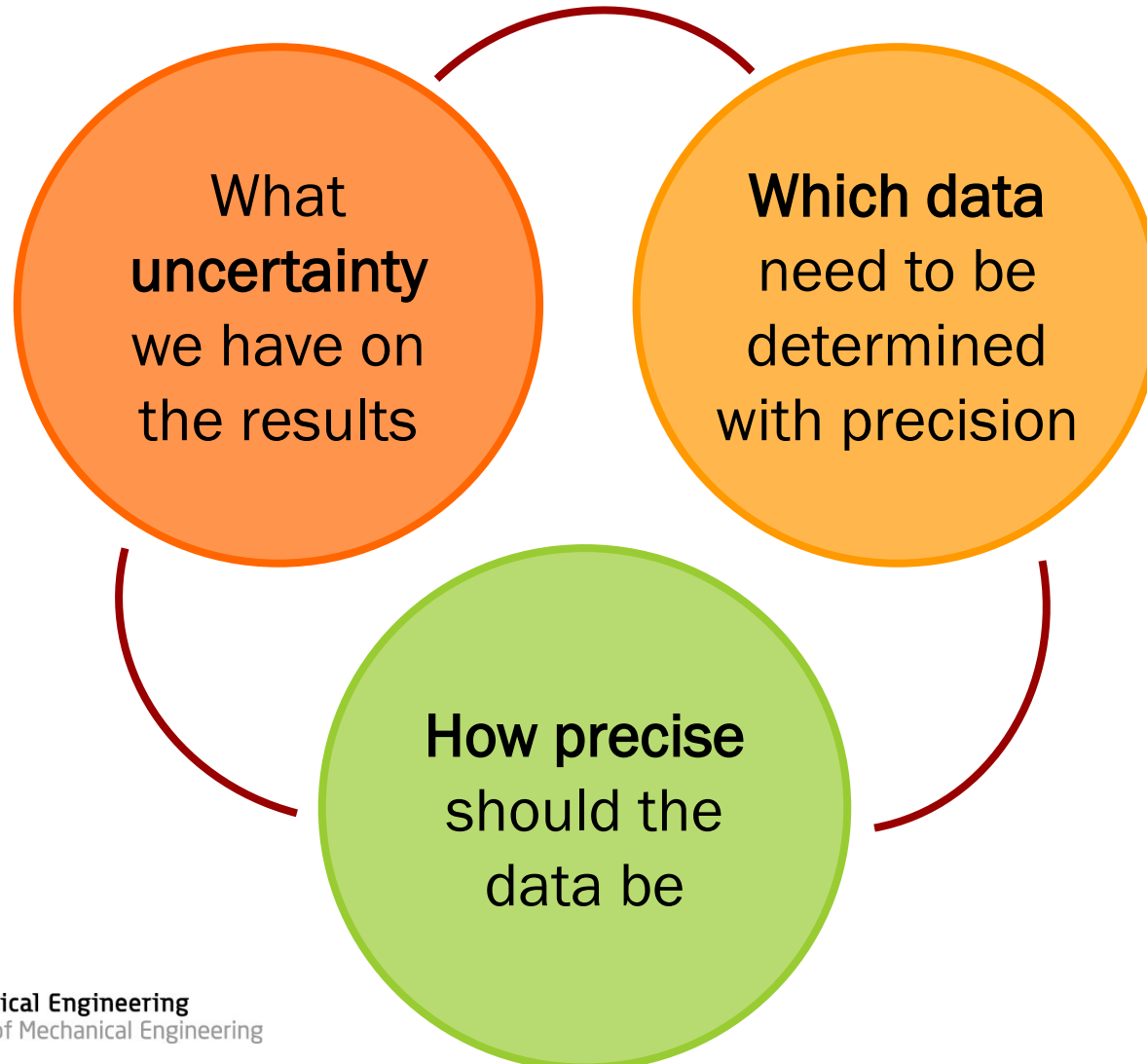

2.7 Data acquisition simplification strategy

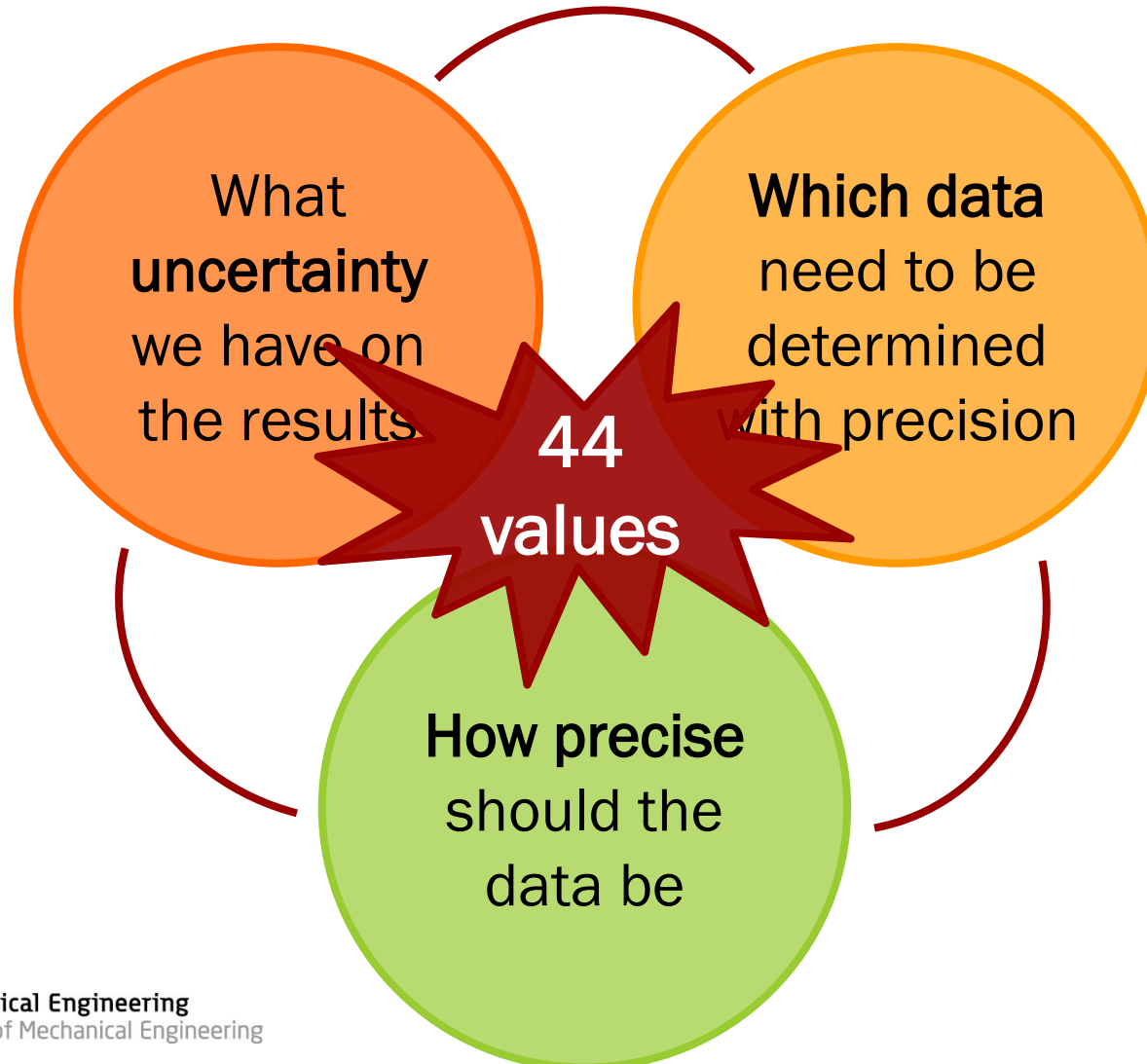

Main questions

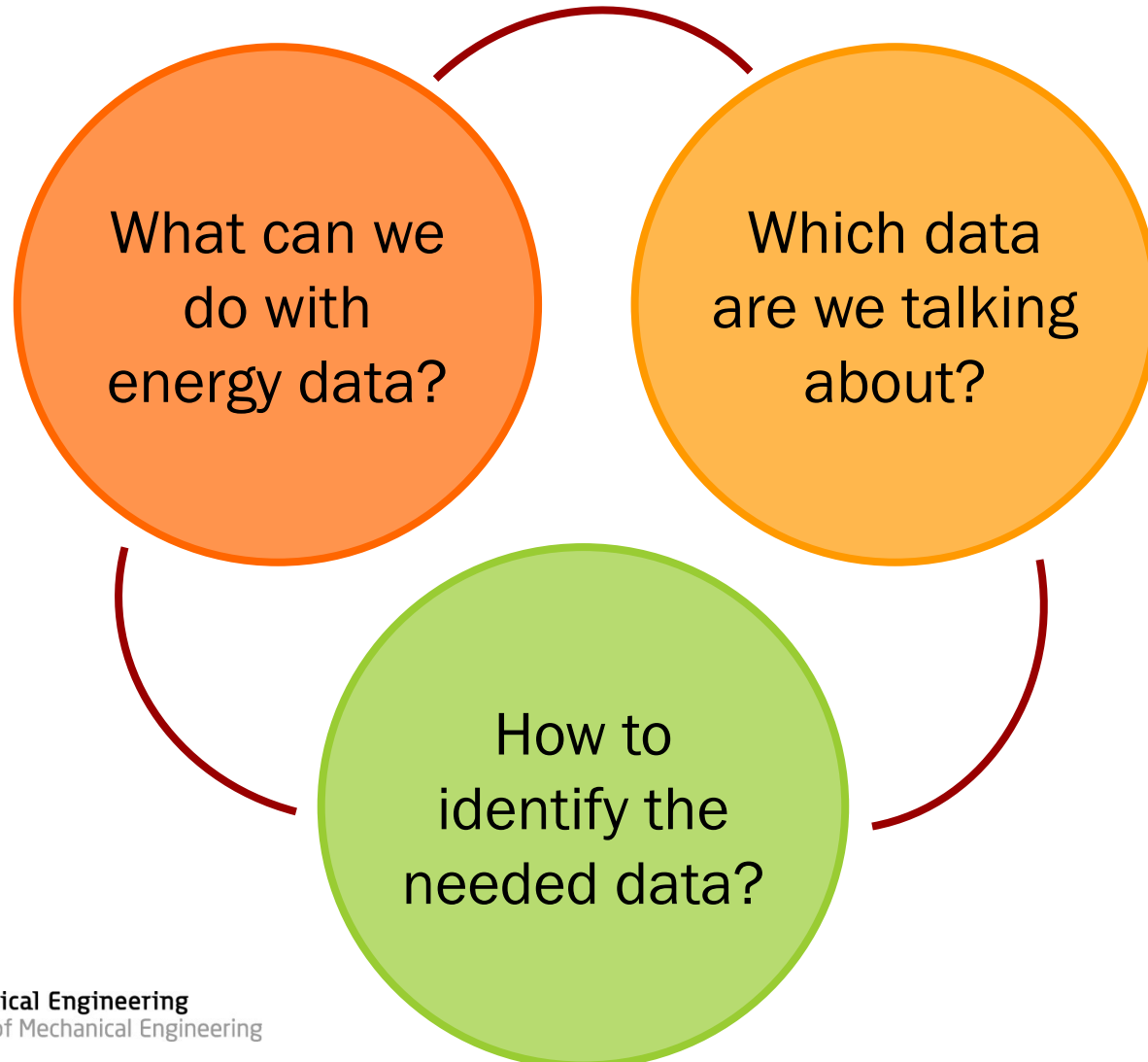

Main questions



Pinch Analysis

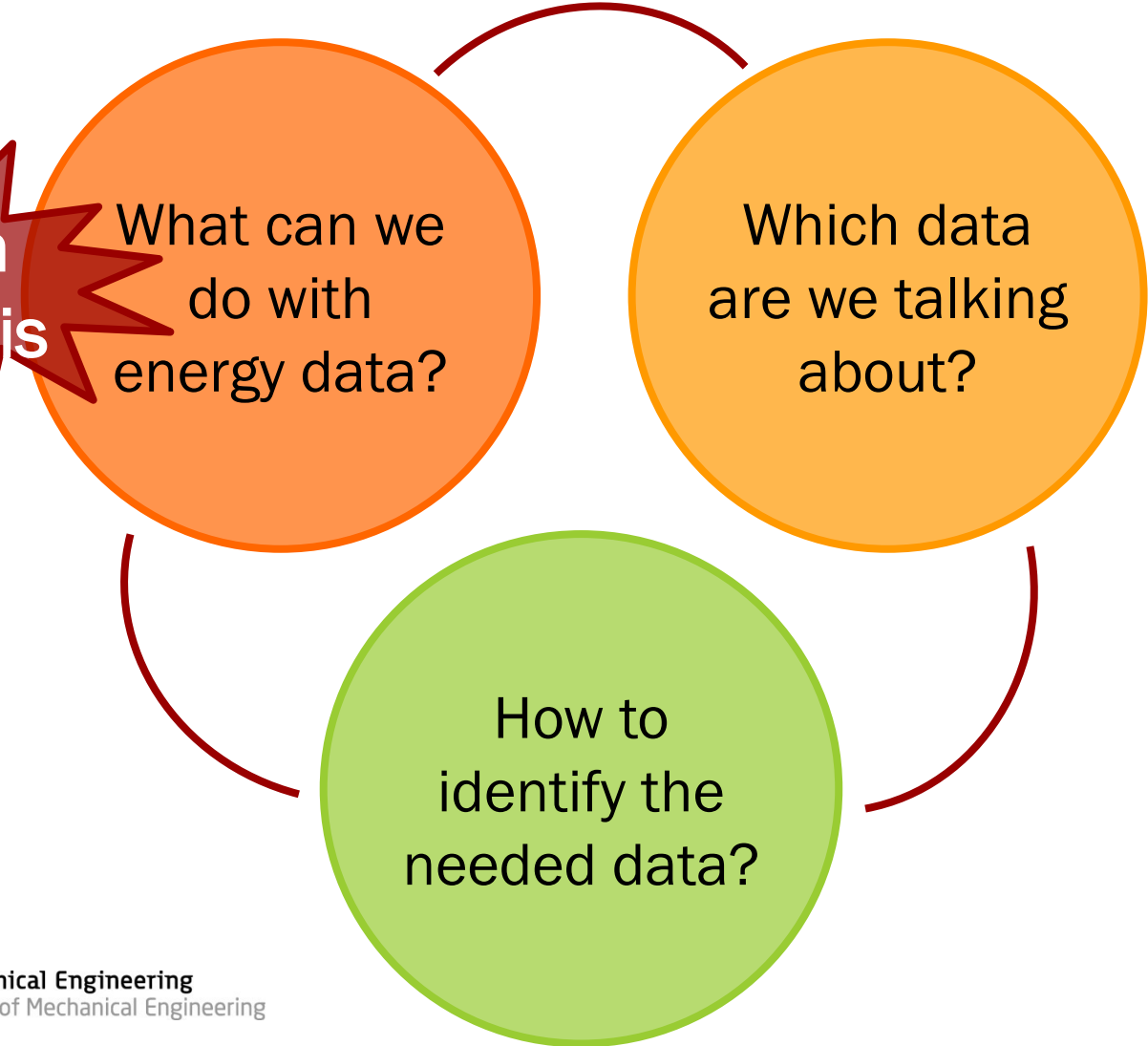

What can we do with energy data?

Which data are we talking about?

How to identify the needed data?

Main questions

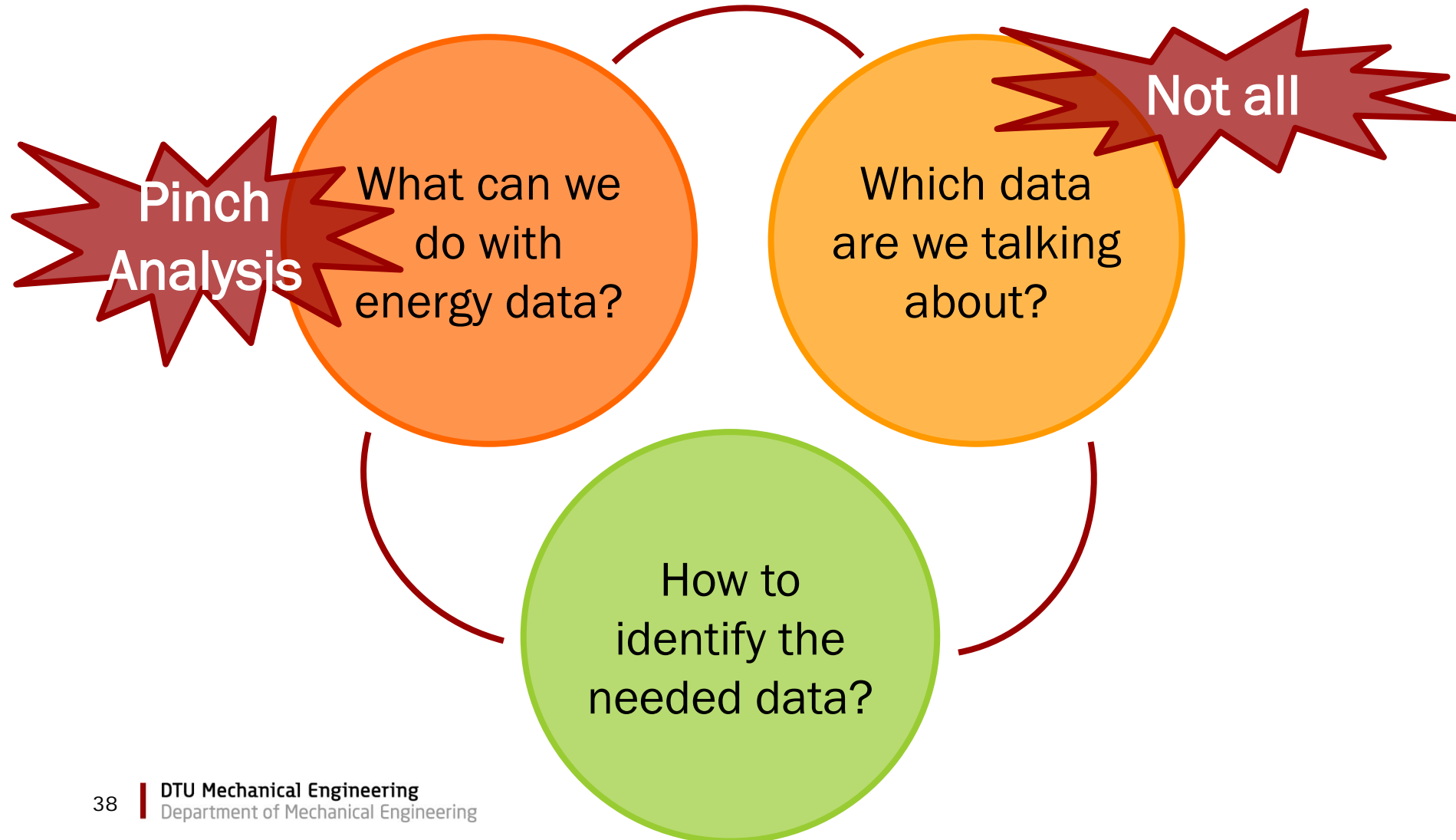

Main questions

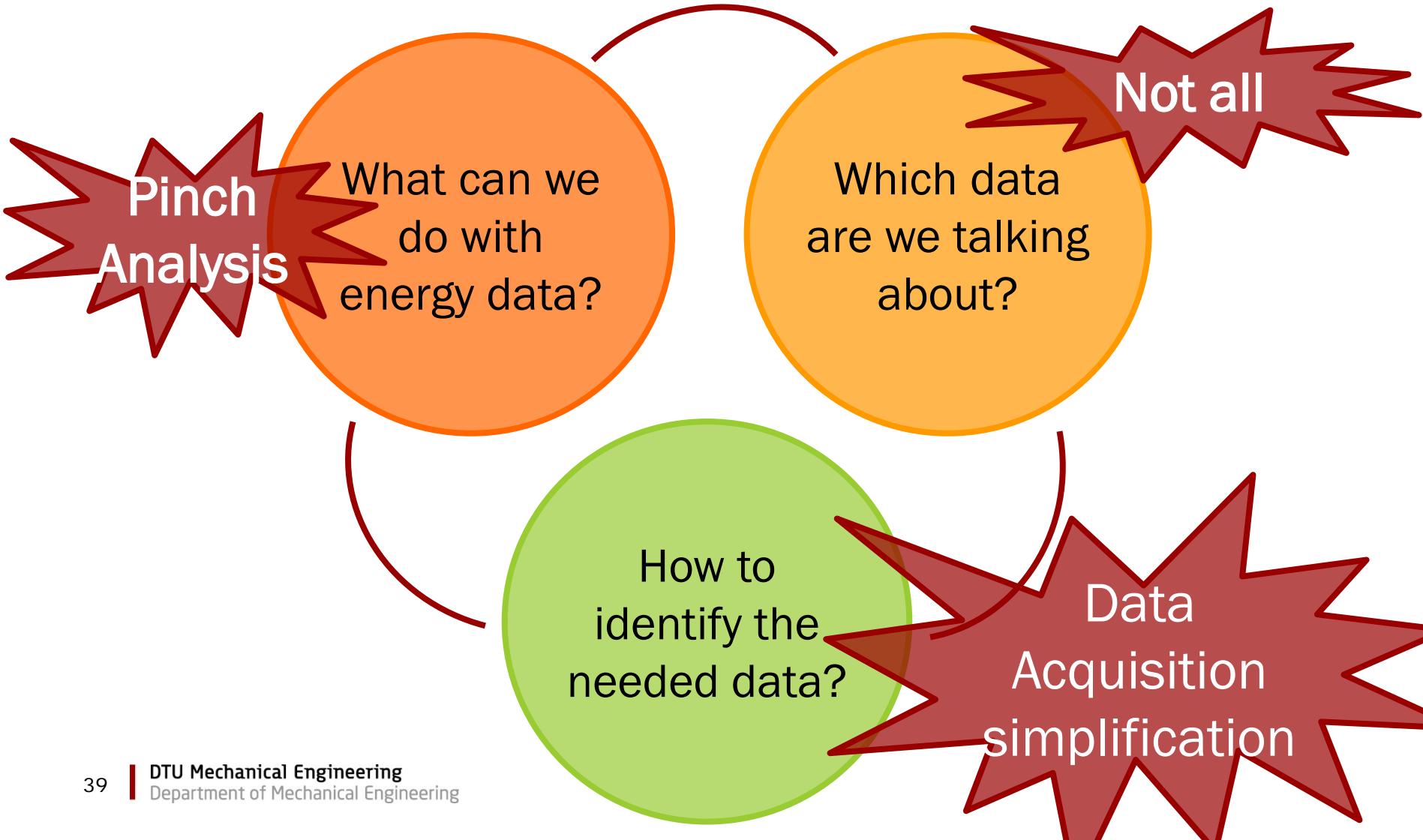

Energy data

What for?

PhD student

Riccardo Bergamini

QUESTIONS?

